

# DEVELON

Mini Excavators

## DX20Z-7



Maximum power	10.3 kW
Operating weight	1995 kg
Bucket capacity	0.05 m <sup>3</sup>

# THE BEST SOLUTION FOR CONFINED AND NARROW JOB SITES







**DEVELON DX20Z-7 MINI EXCAVATOR:**

# **AN ALL-ROUND IMPRESSIVE PACKAGE**

Develon's new DX20Z-7 Mini Excavator offers a host of redesigned features and new technologies to ensure smooth operation, superior productivity, stability and top-class operator comfort.

# RAISE PROFITS, PRODUCTIVITY & FUEL EFFICIENCY

## DELICATE AND PRECISE DRIVING CONTROL

When walking, the compound action of the working device is more rapid, smooth and stable. Narrow spaces are easy to enter and exit, and operation is easy, which makes road construction, ditch cleaning, indoor and outdoor demolition, etc. quick and effective.

### PERFORMANCE

- Compact & powerful machine that adapts to any work site
- Large hydraulic capacity of a tool carrier
- Reliable Stage V engine
- Independent 3-pump hydraulic system guarantees smooth compound operation
- Flexibility to meet customers' different needs

### CONVENIENCE

- Designed for easy maintenance
- Front LED light
- Front cylinder guard plate
- Pedals that facilitate work on slopes
- Rubber tracks
- Engine emergency stop button

### COMPACTNESS

- Sophisticated appearance
- Rotates without tail
- Lateral movement of the upper arm
- Adjustable blade width





### **ADAPTABLE & SMOOTH**

The DX20Z-7's open center hydraulic system with variable displacement pumps uses the engine's power more efficiently, maximizing pump output and offering more comfort, smoothness and accuracy.

### **FLEXIBILITY**

- Fast cycle times, together with class-leading breakout forces, ensure maximum productivity
- Boom and arm cylinder cushioning increases overall smoothness
- Retractable undercarriage lets you enter buildings through the doors
- Retractable front blade and undercarriage enable you to achieve this reduced width – while the machine provides top-class stability in normal operation

# INGENIOUS FLEXIBILITY

## ENGINE

The 3-cylinder combustion Stage V engine brings maximum traction force (1573 t) and gradeability. 10.3 kW - 13.8 hp engine power and the hydraulic pumps (2 × 17.6 + 13.2 l/min) guarantee top performance in its class.



## INTEGRATED COUNTERWEIGHT

Designed to improve the stability of the equipment and to make your job safer, comfortable and efficient.

## ZERO TAIL SWING

Thanks to Zero tail swing design, the operator can fully use the machine without fear of damage even in narrow spaces, such as when working close to a wall. The front upper structure corners are fully protected within the swing circle.

## LARGE BOOM SWING ANGLE

The swing bracket and the boom swing cylinder size ensure powerful and stable performance. The boom can swing left and right to handle a wide scope of operations at the job site.





## TRACK WITH ADJUSTABLE WIDTH

Stability is essential for making maximum use of the digging forces and lifting capacities. Optimum stability is achieved by fully expanding the retractable undercarriage and using the long dozer blade. The following features make the stability of the Develon DX20Z-7 very competitive with all other zero tail swing machines on the market:

### 1. Retractable undercarriage:

When fully retracted – minimum width is 950 mm – the undercarriage allows the excavator to go through narrow spaces. When fully expanded – maximum width of extended track is 1360 mm – the undercarriage provides optimum stability for the excavator, especially when working over the side.

Safe and stable work is guaranteed – with additional benefits of easy transportation.

2. Adjustable blade: On top of its dustpan functionality, the dozer blade also significantly improves front stability, enabling the operator to fully use the breakout forces the machine delivers.



## HIGHER BLADE APPROACHING ANGLE

Welded, unitized blade provides durability even under harsh working conditions. Automatically controlled blade floating for quick and easy leveling operations.

The sides of the blade can be used with adjustable width, according to the working conditions. The maximum 33° approaching angle makes transportation easier.

## EXPEDIENT

The distance between the blade and the bucket is set to the minimum – making it convenient for the push shovel and the bucket to shovel soil.



# SAFE AND COMFORTABLE WORKING ENVIRONMENT

## LED LIGHT ON THE BOOM

As standard, we have mounted a high-luminant LED light on the boom – ensuring safe and well-lit working conditions at night and in dark indoor areas.



## CYLINDER PROTECTION

Protective devices are installed on the arm, bucket and dozer cylinders to prevent damage by external objects.

## EMERGENCY STOP SWITCH

In case of emergency, this switch cuts off engine fuel supply to ensure the operator's safety.

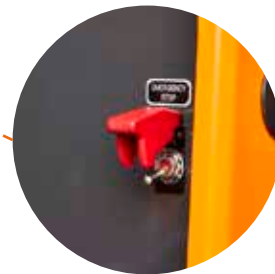

## DETACHABLE CANOPY

- Can be removed according to the operator's needs
- TOPS certified, safe, secure and convenient
- The space under the canopy is accessible from both sides





# OPERATING IN COMFORT

## THE IDEAL WORKSPACE DESIGNED AROUND YOU

The sophisticated ISO-certified TOPS canopy – together with excellent visibility and stability – provide optimal operator comfort and safety. Comfortably seated, you have easy access to several storage compartments and a clear all-round view of the worksite. Noise and vibration levels are minimized.

### DRIVER'S SEAT COMFORT

Spacious cab with ample leg room, robust ergonomic pedals, large & flat floor, adjustable seat with arm rests ensuring reduced driver fatigue. The DX20Z-7 has joysticks (not levers) like large excavators – helping you work in greater comfort and more precise detail.



### WIDE FRONT VISIBILITY

- A large comfortable and cleverly designed service area
- Look at the ground during the operation, without hindering the job
- Clear visibility to improve job safety



### BATTERY BOX

Convenient to replace and maintain (placed on the operator's right).



### STORAGE COMPARTMENTS

- The seat back cover storage clip is easy to reach and access
- Flexible opening and closing
- Cup holder inside the machine provides additional comfort during operation



# BEST MAINTENANCE ACCESS

## MORE DURABILITY – LESS MAINTENANCE

### MAINTENANCE ACCESS MADE SIMPLE

- A battery cut-off switch makes it easy to disconnect the battery during long-term storage
- The hour meter display can be easily checked from ground level
- For extra accessibility and servicing convenience, all filters (engine oil filter, fuel pre-filter, fuel filter and pilot filter) are accessible from ground level

### AIR BREATHER

The hydraulic system was designed to prevent the pump from cavitating.

### STRENGTHENED BOOM

Using finite elements and 3-dimensional computer simulation, the shape of the boom has been optimally designed for better load distribution throughout the structure. This enhancement, combined with increased material thickness, limits element fatigue for improved durability and reliability.

### ARM ASSEMBLY

Greater strength in the arm assembly is gained by using cast elements and reinforcement around the bosses to increase the life of the component.

### RUBBER TRACKS

The rubber tracks offer greater non-slip and grip capabilities, and are less harmful to sidewalks and road surfaces in urban environments. These rubber shoes can be easily installed or removed with the idler, sprocket and other main parts.

### ENGINE ROOM

The engine compartment is designed for easier service, and the sturdy sound-proofing inside the engine cover reduces the noise to provide a more comfortable environment for the operator and those working around the machine.

### OIL GAUGE

Hydraulic oil level can be easily checked through the gauge on the side of the hydraulic tank.

### GREASE PIPING

Integrated grease piping is designed for easy maintenance of the swing bearing and boom swing cylinder.

### EXTERNAL FUEL CAP

The external lockable fuel cap makes refueling easy and safe. For extra convenience, a warning beep sounds when the maximum fuel level has been reached.

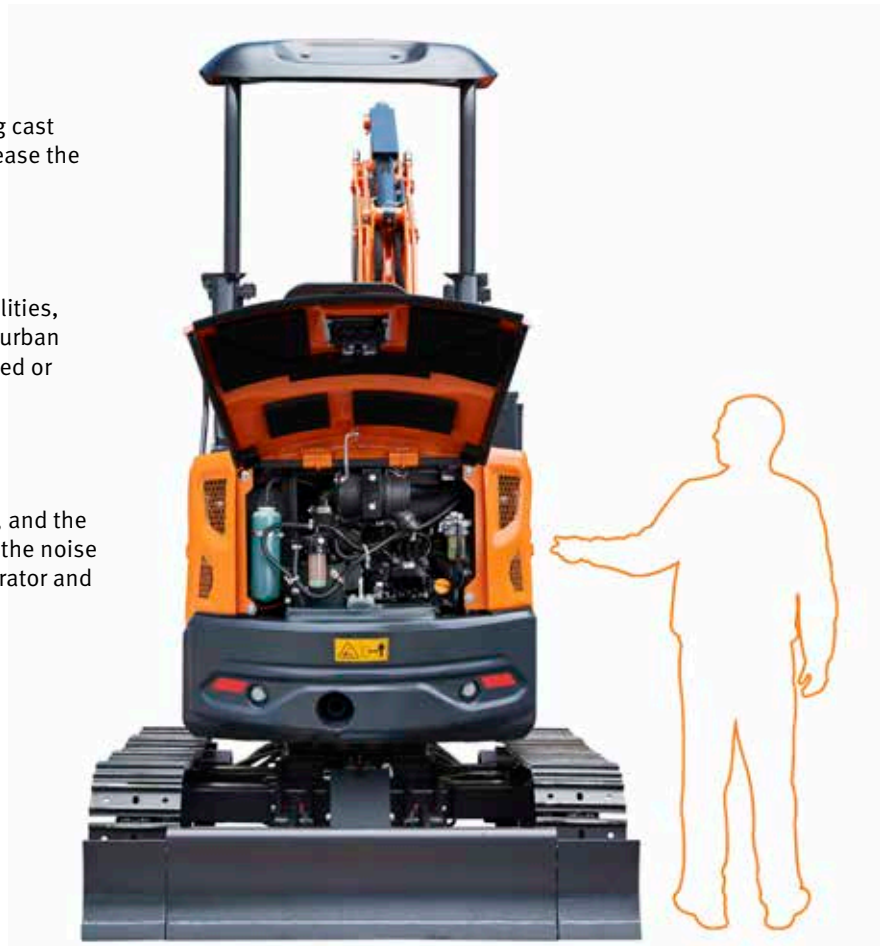





# TECHNICAL SPECIFICATIONS

## ENGINE

Designed to deliver superior performance and fuel efficiency, the Yanmar 3TNV70 diesel engine fully meets the latest Stage V emission regulations. To optimize machine performance, the engine uses high-pressure fuel injectors, air-to-air inter-cooler and electronic engine controls.

### Model

Yanmar 3TNV70

### No. of cylinders

3

### Rated power at 2200 rpm

ISO 14396 10.3 kW (13.8 hp)

### Max. torque at 1600 rpm

47.6 ~ 51.9 Nm (5.3 kgf·m)

### Idle (low - high)

1450 - 2375 rpm

### Displacement

854 cm<sup>3</sup>

### Bore × stroke

70 mm × 74 mm

### Starter

12 V × 1.4 kW

### Batteries - Alternator

1 × 12 V, 52 Ah – 12 V, 40 A

### Air filter

Double element air cleaner

## UNDERCARRIAGE

Extremely robust construction throughout – made of high-quality, durable materials, with all welded structures designed to limit stresses.

- Track rollers lubricated for life
- Idlers and sprockets fitted with floating seals
- Track shoes made of induction-hardened alloy with triple grouser
- Heat-treated connecting pins
- Hydraulic track adjuster with shock-absorbing tension mechanism

### Upper rollers (standard shoe)

NOT APPLICABLE

### Lower rollers

3

### Number of links & shoes per side

72

### Link pitch

48 mm

## HYDRAULIC SYSTEM

2-travel speeds offer either increased torque or high speed

### Main pump

Variable axial piston pump

Maximum flow at rated rpm 2 × 17.6 l/min

Gear pump

Maximum flow at rated rpm 13.2 l/min

### Pilot pump

Gear pump

Maximum flow at rated rpm 5.94 l/min

## HYDRAULIC CYLINDERS

High-strength steel piston rods and cylinder bodies. Shock absorbing mechanism fitted in all cylinders for shock-free operation and extended piston life.

Cylinders	Quantity	Bore × rod diameter × stroke (mm)
Boom	1	60 × 35 × 439
Arm	1	55 × 35 × 425
Bucket	1	55 × 30 × 315
Dozer	1	70 × 35 × 118
Boom swing	1	60 × 30 × 323

## SWING MECHANISM

The swing mechanism uses an axial piston motor, driving a 2-stage planetary reduction gear bathed in oil for maximum torque.

- Swing bearing: single-row, shear type ball bearing with induction hardened internal gear
- Internal gear and pinion immersed in lubricant

### Maximum swing speed

9.6 rpm

### Maximum swing torque

248 kgf·m

## DRIVE

Each track is driven by an independent, high-torque axial piston motor through a planetary reduction gearbox. 2 levers / foot pedals guarantee smooth travel with counter-rotation on demand. The track frame protects the travel motor, brake and planetary.

### Travel speed (low - high)

2.02 - 3.71 km/h

### Maximum traction

1.573 - 0.731 t

### Maximum gradeability

16.7° / 30%

## CAB

The sophisticated ISO-certified TOPS pillar canopy – together with excellent visibility and stability – provides optimal operator comfort and safety. Comfortably seated, you have easy access to storage compartments and a clear all-round view of the work site. Noise and vibration levels are minimized.

### A-weighted emission sound pressure level at the operator's position, LpAd (ISO 6396)

Declared: 76 dB(A)

### A-weighted sound power level, LwAd (2000/14/EC)

Measured: 92 dB(A)

## FLUID CAPACITIES

Fuel tank	20 l
Cooling system (radiator)	3.2 l
Hydraulic oil tank	25.5 l
Engine oil	2.8 l
Travel device	2 × 0.35 l

## WEIGHT & GROUND PRESSURE

	Machine weight (kg)	Ground pressure (bar)
230 mm rubber shoes	1915	0.301

## COMPONENT WEIGHTS

Item	Weight (kg)	Remarks
Machine (w/o front)	1664	
Upper structure (w/o front, counterweight)	1037	Boom swing bracket included
Canopy upper	23	
Canopy lower	14	
Counterweight	201	
Undercarriage	626	Dozer included
Dozer	85	
Dozer (center)	64	
Dozer extension	9.6	LH, RH each
Dozer cylinder	11	
Rubber shoe	60	each
Front assembly	230	
Boom	77	Piping included
Arm	55	Piping & links included
Bucket	50	
Boom cylinder (with cover)	18	
Arm cylinder (with cover)	16	
Bucket cylinder (with cover)	13	

## ARMS

	Length (mm)	Weight (kg)	Digging force (ISO) (ton)
<b>DX20Z-7 (Standard)</b>	1100	35	0.762

## BUCKETS

	Capacity (m³) ISO	Width (mm)		Weight (kg)	Digging force (ISO) (ton)
		with side cutters	w/o side cutters		
<b>DX20Z-7 (recommended)</b>	0.05	511	485	50	1.551

# DIMENSIONS & WORKING RANGE

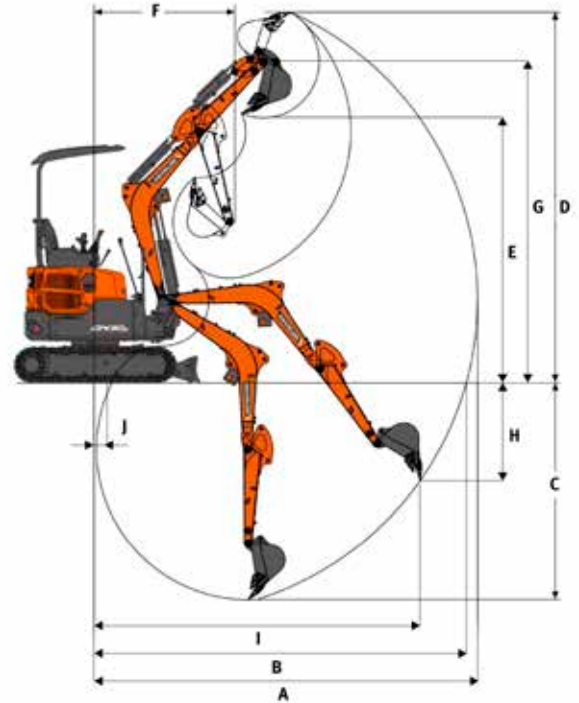
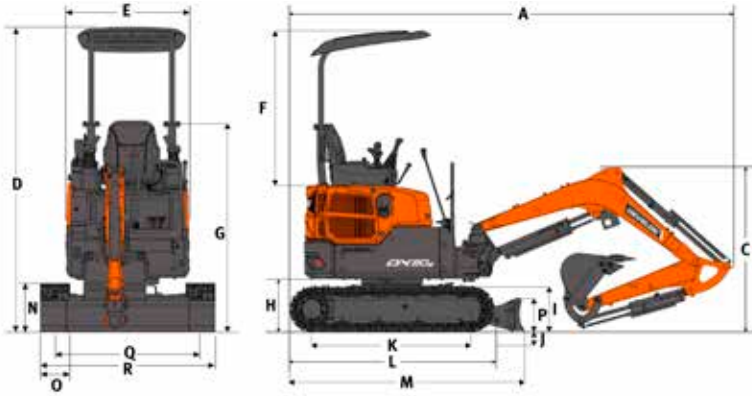

## DIMENSIONS

	mm	
<b>Boom length</b>	<b>mm</b>	<b>1725</b>
<b>Arm length</b>	<b>mm</b>	<b>1100</b>
<b>Bucket capacity (ISO)</b>	<b>m<sup>3</sup></b>	<b>0.05</b>
<b>Track shoe</b>	-	<b>Rubber</b>
A Shipping length	mm	3483
Tail swing radius	mm	690
C Shipping height (boom)	mm	1340
D Shipping height over canopy	mm	2360
E Upper structure width	mm	950
F Canopy height above engine hood	mm	1209
G Ground ~ lower canopy structure	mm	1605
H Counterweight clearance	mm	419
I Dozer blade max. lifting height	mm	251
J Dozer blade max. lowering depth	mm	234
Bucket to dozer distance	mm	216
K Tumbler distance	mm	1258
L Track length	mm	1612
M Undercarriage length with dozer	mm	1847
N Track height	mm	356
O Shoe width	mm	230
P Dozer blade height	mm	265
Q Track gauge	mm	720 (1130*)
R Overall width	mm	950 (1360*)

\* Track extended

## WORKING RANGE













	mm	
<b>Boom length</b>	<b>mm</b>	<b>1725</b>
<b>Arm length</b>	<b>mm</b>	<b>1100</b>
<b>Bucket capacity (ISO)</b>	<b>m<sup>3</sup></b>	<b>0.05</b>
<b>Track shoe</b>	-	<b>Rubber</b>
A Max. digging reach	mm	3975
B Max. digging reach (ground)	mm	3875
C Max. digging depth	mm	2345
D Max. digging height	mm	3805
E Max. dump height	mm	2750
F Min. swing radius	mm	1565
Tail swing radius	mm	690
G Max. bucket pin height	mm	3315
H Max. vertical wall depth	mm	1120
I Max. radius vertical	mm	3350
J Min. digging reach	mm	20
Boom offset (right)	mm	513
Boom offset (left)	mm	553



# LIFTING CAPACITIES

**BOOM 1725 MM • ARM 1100 MM • W/O BUCKET • 230 MM RUBBER SHOES  
OVER BLADE • BLADE UP**



(UNIT: 1000 KG)

A	1.0 m		1.5 m		2.0 m		2.5 m		3.0 m		Max. reach		A
													

**BOOM 1725 mm • ARM 1100 mm • W/O BUCKET • 230 mm RUBBER SHOES**

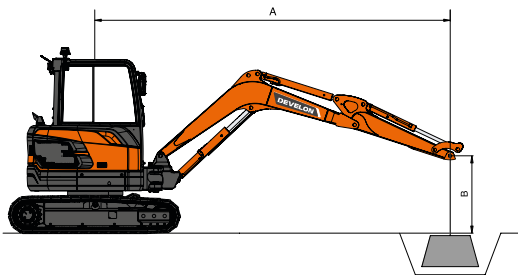
3.0 m											0.33 *	0.33 *	2.32
2.5 m							0.30 *	0.30 *			0.28 *	0.28 *	2.83
2.0 m							0.32 *	0.32 *	0.31	0.32	0.26 *	0.26 *	3.15
1.5 m					0.41 *	0.41 *	0.37 *	0.37 *	0.3	0.32	0.26	0.26 *	3.33
1.0 m					0.55	0.57	0.39	0.41	0.3	0.31	0.24	0.26	3.41
0.5 m					0.53	0.55	0.38	0.4	0.29	0.31	0.24	0.26	3.39
0.0 m			0.77 *	0.77 *	0.52	0.54	0.37	0.39	0.29	0.3	0.25	0.27	3.29
-0.5 m	0.76 *	0.76 *	0.83	0.86	0.51	0.54	0.37	0.39	0.29	0.3	0.28	0.29	3.08
-1.0 m	1.12 *	1.12 *	0.84	0.87	0.52	0.54	0.37	0.39			0.33	0.35	2.72
-1.5 m	1.31 *	1.31 *	0.72 *	0.72 *	0.47 *	0.47 *					0.40 *	0.40 *	2.13



 : Rating over front.  
 : Rating over side or 360°.

- Lifting capacities are in compliance with ISO 10567.
- The load point is at the end of the arm.
- \* limited hydraulic lift capacities.
- Lift capacities do not exceed 75% of minimum tipping loads or 87% of hydraulic lifting capacity.
- For lifting capacity with bucket, simply subtract the actual weight of the bucket from the values.
- Lift capacities apply only to the machine as originally manufactured and normally equipped by the manufacturer.
- The configurations indicated do not necessarily reflect the standard equipment of the machine.

# STANDARD AND OPTIONAL EQUIPMENT

● Standard ○ Optional

## Engine

- Yanmar 3TNV70 water-cooled, indirect injection
- Stage V

## Cab & interior

- 2 pillar (detachable) canopy
- ZHS upper-structure concept
- Track expansion switch
- Stationary seat
- Small storage compartment
- 2-speed travel
- 4 pillars canopy

## Hydraulic System

- Hydraulic joystick control
- One way flow auxiliary lines on arm

## Safety

- Battery switch-off
- Boom light protection, metal
- Boom LED lights
- Bucket and arm cylinder guards
- Battery cover

## Other

- 1.1 m arm
- 1.725 m boom

## Undercarriage

- Extendable undercarriage
- 950 mm dozer blade with two blade extensions (1360 mm extended)

## List of attachments

- Develon Hydraulic Breaker HB03H, 700-1200 bpm, 120 dB

# OPTIONAL ATTACHMENTS

## NEED A BREAK?



Available on 1 to 10 tons Excavators

### OPTIMIZED PERFORMANCE

HB series are optimized for Develon Excavators, fully certified by Develon engineering.

### PERFORMANCE

Develon HB breakers offer powerful performance and top notch productivity, whether you are demolishing concrete or breaking rocks.

### WARRANTY

Avoid compatibility and warranty coverage arguments from using non-approved breaker. Develon offers standard warranty up to 2 years.

### TOTAL COST OF OWNERSHIP

Even with 2-year warranty, HB-series are offered at reasonable price, providing customer benefits in total cost of ownership.

## BUCKETS SETS

Whatever the width, tackle any digging operation with our buckets sets.

Available on 1 to 10 tons Excavators

Each set contains:

- 1 pin-on quick coupler
- 3 digging buckets with teeth
- 1 grading bucket

### SIDE CUTTERS & BOTTOM WEAR STRAPS

The digging buckets are equipped with thick and chamfered side cutters, and bottom wear straps covering 90% of the bottom of the bucket.

### INCREASED STIFFNESS

The grading bucket is equipped with one or more web plates to increase the stiffness of the bucket.











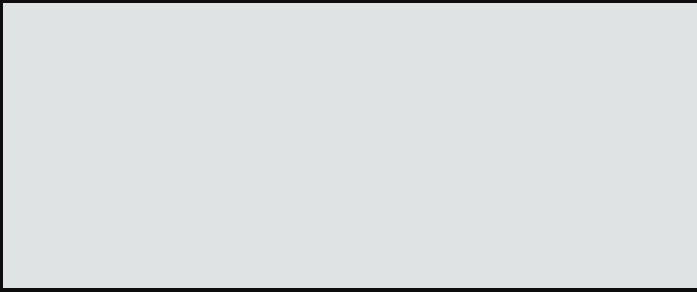

# Powered by Innovation

DISCOVER MORE:  
DX20Z-7

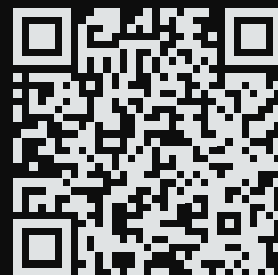

# DEVELON

HD Hyundai Infracore Europe s.r.o.  
IBC - Pobřežní 620/3, 186 00 Praha 8-Karlín  
Czech Republic

©2023 DEVELON D4601182-EN (08-23)

Certain specification(s) are based on engineering calculations and are not actual measurements. Specification(s) are provided for comparison purposes only and are subject to change without notice. Specification(s) for your individual Develon equipment will vary based on normal variations in design, manufacturing, operating conditions, and other factors. Pictures of Develon units may show other than standard equipment.